

Data Sheet



Article number: 604132032020

Description: Taper bored timing belt pulley
HTD 32 8M 20 TL 1610

Measures

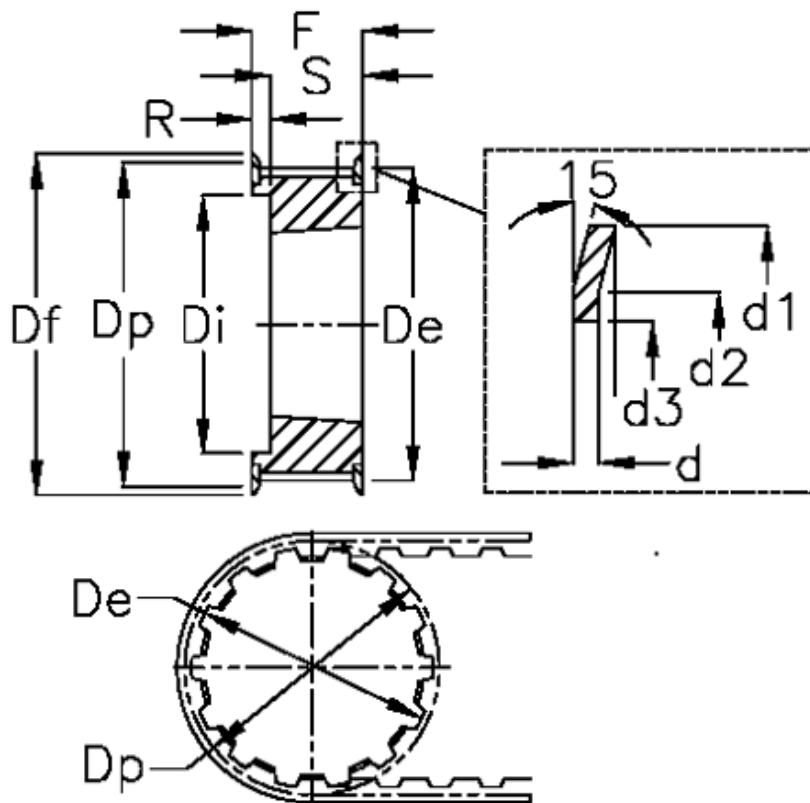

d = 1.5	F = 28	Weight = 0.42
d1 = 87	Flange type = F30	Width = 20
d2 = 82.5	For bushing = 1610	
d3 = 72	Max bore = 42	
De = 80.16	r = 3	
Df = 87	S = 25	
Di = 63	Tooth number = 32	
Dp = 81.49	Type = 8M	